

BELKIN®

**OmniView® PR03
Dual-User KVM Switch**

Start Here →

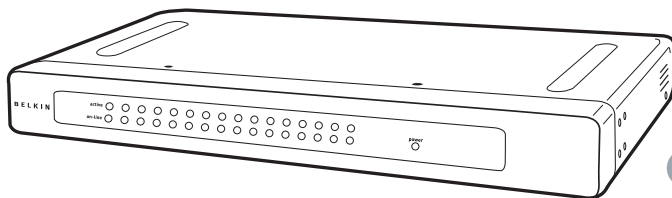

EN

FR

DE

NL

ES

IT

Quick Installation Guide

F1DA208Zea
F1DA216Zea

To install the Switch, you will need the following:



OmniView PRO3
Dual-User KVM
Switch (included)



Rack-Mount
Brackets with
Screws (included)



12V/1A Power
Supply (included with
Schuko and Uk plug)



VGA Monitor



USB or PS/2 Keyboard



USB or PS/2 Mouse



Belkin Dual-Port
Micro-Cable Kit
[Belkin Part No. F1D9400-XX
(PS/2-style) or F1D9401-XX
(USB-style)]

Introduction

This Quick Installation Guide will guide you through the steps needed to install the OmniView PRO3 Dual-User KVM Switch (the Switch).

If you have any problems during this installation, please refer to the User Manual.

Step 1. Mount the Switch

The PRO3 Dual-User KVM Switch includes adjustable mounting brackets ideal for installation in 19-inch racks. The mounting brackets feature three adjustment positions to allow you to set the Switch's face flush with the ends of the rails or to extend the Switch past the front of the rails. Please follow these simple steps to achieve the desired adjustment.

- 1.1** Determine how far you would like the Switch to protrude from the rack. Select a bracket-hole scheme.
- 1.2** Attach the bracket to the side of the Switch using the Phillips screws provided. (Refer to diagram below.)

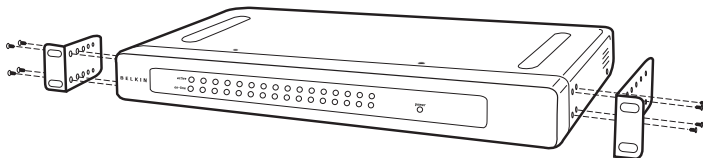

The PRO3 Dual-User KVM Switch includes adjustable mounting brackets ideal for installation in 19-inch racks. The mounting brackets feature three adjustment positions to allow you to set the Switch's face flush with the ends of the rails or to extend the Switch past the front of the rails. Please follow these simple steps to achieve the desired adjustment.

1.3 Mount the Switch to the rack rails. (Refer to diagram below.)

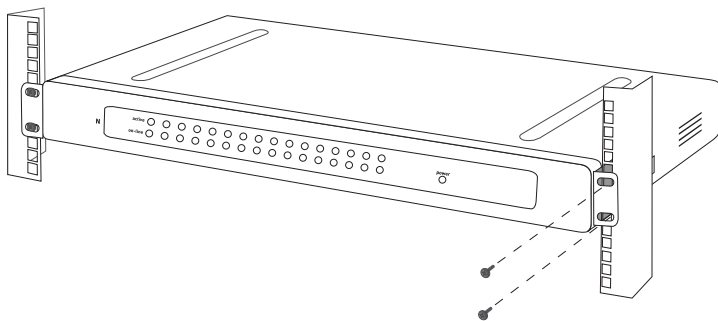

Your Switch is now mounted securely to the rack and you are ready to connect the console.

Step 2. Connect the Console

- 2.1** Connect your monitor VGA cable to the VGA port on the back of the Switch in the “Console” section. (Refer to diagram below.)

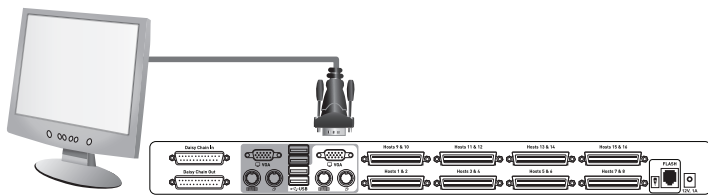

- 2.2** Connect your keyboard and mouse cables to the keyboard and mouse ports on the back of the Switch in the “Console” section. (Refer to diagram below.)

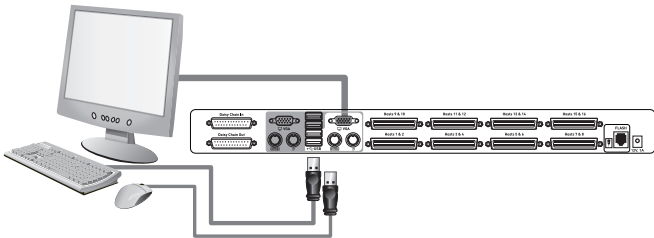

- 2.3** Repeat Steps 2.1 and 2.2 for connecting the second console.
- 2.4** Attach one end of the Belkin Dual-Port Micro-Cable Kit to the Switch and then attach the other end to the server. (Refer to diagram below.)

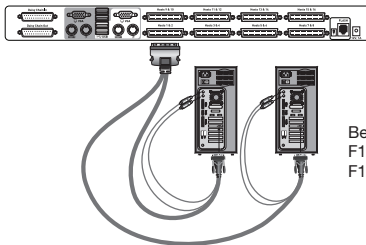

Belkin Dual-Port Micro-Cable Kits:
F1D9400-XX (PS/2-style)
F1D9401-XX (USB-style)

- 2.5** Attach the power supply to the power jack on the back of the Switch. (Refer to diagram below.)

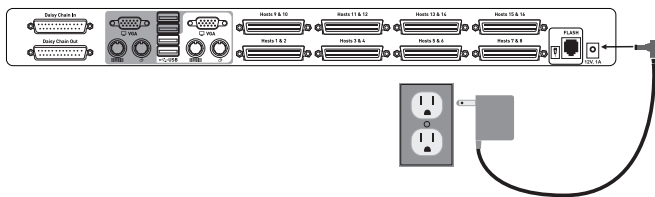

- 2.3** Power up the connected servers. Check for keyboard, video, and mouse function on each port. (Refer to diagram below.)

To install your Switch in a daisy-chain configuration, please refer to the User Manual.

BELKIN®**OmniView® PR03
Dual-User KVM Switch**
BELKIN®

www.belkin.com

Belkin Ltd.
+44 (0) 1933 35 2000
Rushden, United Kingdom

Belkin B.V.
+31 (0) 20 654 7300
Schiphol-Rijk, Netherlands

Belkin Sweden
+46 (0) 8 510 630 00
Stockholm, Sweden

Belkin SAS
+33 (0) 1 41 03 14 40
Boulogne-Billancourt, France

Belkin Iberia
+34 91 791 23 00
Alcobendas, Spain

Belkin Nordics & Baltics
+45 (0) 3612 6000
Brøndby, Denmark

Belkin GmbH
+49 (0) 89 143405 0
Munich, Germany

Belkin Italy & Greece
+39 02 862 719
Milano, Italy

Belkin Ltd.
+971 (0) 4 369 2705
Dubai Internet City, Dubai, UAE

© 2008 Belkin International, Inc. All rights reserved. All trade names are registered trademarks of respective manufacturers listed.

PM00015ea



BELKIN®

OmniView® PR03
Switch KVM pour deux
utilisateurs

Commencez ici →

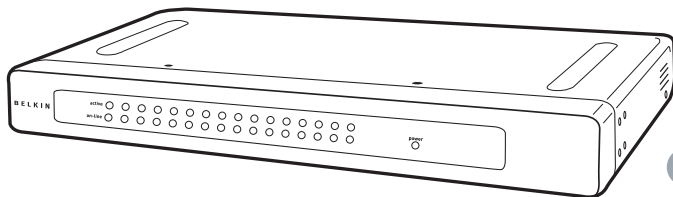

EN

FR

DE

NL

ES

IT

Guide d'installation rapide

F1DA208Zea
F1DA216Zea

Pour installer le switch, vous avez besoin des éléments suivants:



OmniView PRO3
Switch KVM pour
deux utilisateurs
(fourni)



Fixations de montage
en baie avec
vis (fournies)



Source d'alimentation
12 V/1 A
(prises anglaise et CEE
fournies)



Moniteur VGA



Clavier USB ou PS/2



Souris USB ou PS/2



Kit de microcâblage
double port Belkin
[références Belkin
F1D9400-XX (PS/2) ou
F1D9401-XX (USB)]

Introduction

Ce guide d'installation rapide vous guidera à travers les étapes nécessaires à l'installation du Switch KVM OmniView PRO3 pour deux utilisateurs (le switch). Si vous rencontrez des problèmes lors de l'installation, veuillez consulter le manuel de l'utilisateur.

Étape 1. Montage du switch

Le switch KVM PRO3 pour deux utilisateurs est livré avec des fixations de montage réglables qui conviennent parfaitement à l'installation dans des baies 19 pouces. Les supports de montage peuvent être ajustés selon trois positions, ce qui permet de placer la face du switch de façon à ce qu'elle soit alignée avec la fin des rails ou pour placer le switch de façon à ce qu'il dépasse le devant des rails. Procédez comme suit pour obtenir facilement le réglage souhaité.

- 1.1 Déterminez la profondeur à laquelle vous désirez installer le switch dans la baie. Choisissez les orifices correspondants sur les fixations.
- 1.2 Fixez le support de montage sur le côté du switch à l'aide des vis cruciformes fournies. (Reportez-vous à l'illustration ci-dessus.)

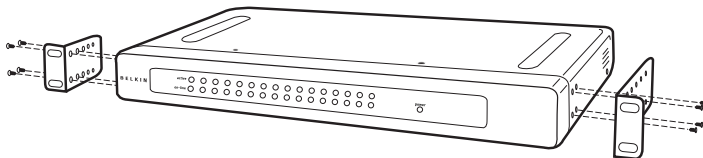

Le switch KVM PRO3 pour deux utilisateurs est livré avec des fixations de montage réglables qui conviennent parfaitement à l'installation dans des baies 19 pouces. Les supports de montage peuvent être ajustés selon trois positions, ce qui permet de placer la face du switch de façon à ce qu'elle soit alignée avec la fin des rails ou pour placer le switch de façon à ce qu'il dépasse le devant des rails. Procédez comme suit pour obtenir facilement le réglage souhaité.

- 1.3** Montez le switch dans la baie.
(Reportez-vous à l'illustration ci-dessus.)

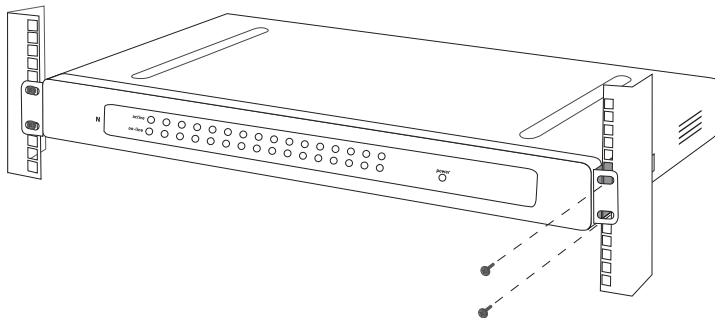

**Votre switch est maintenant solidement ancré à la baie.
Vous pouvez maintenant brancher la console.**

Étape 2. Branchement de la console

- 2.1** Branchez le câble VGA de votre moniteur au port VGA à l'arrière du switch, dans la section « Console ». (Reportez-vous à l'illustration ci-dessus.)

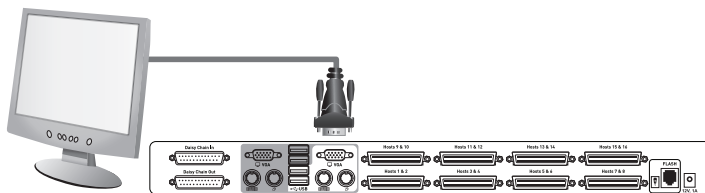

- 2.2** Branchez vos câbles USB de votre clavier et votre souris au ports USB clavier et souris à l'arrière du switch, dans la section « Console ». (Reportez-vous à l'illustration ci-dessus.)

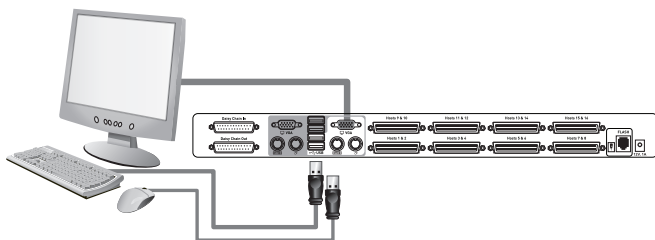

- 2.3** Répétez les étapes 2.1 et 2.2 si vous souhaitez brancher une seconde console sur le switch.

- 2.4** Branchez une extrémité du Kit de microcâblage double port Belkin au switch, et l'autre extrémité au serveur. (Reportez-vous à l'illustration ci-dessus.)

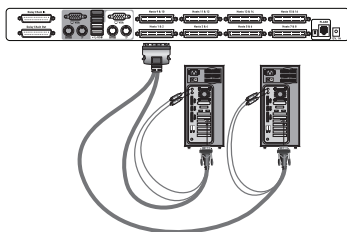

Kits de microcâblage double port
de Belkin :
F1D9400-XX (connecteurs PS/2)
F1D9401-XX (connecteurs USB)

- 2.5** Branchez le cordon d'alimentation à la prise d'alimentation à l'arrière du switch. (Reportez-vous à l'illustration ci-dessus.)

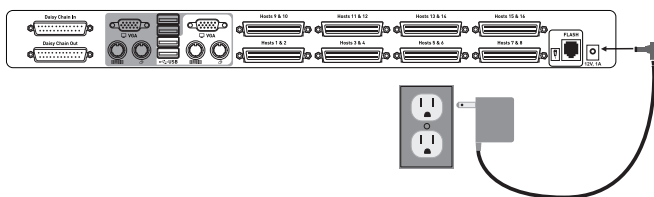

- 2.3** Allumez les serveurs connectés. Vérifiez que le clavier, le moniteur et la souris fonctionnent à chaque port. (Reportez-vous à l'illustration ci-dessus.)

Pour installer votre switch dans une configuration de montage en chaîne, consultez le manuel de l'utilisateur.

BELKIN®

OmniView® PR03 Switch KVM pour deux utilisateurs

BELKIN®

www.belkin.com

Belkin Ltd.
+44 (0) 1933 35 2000
Rushden, Royaume-Uni

Belkin B.V.
+31 (0) 20 654 7300
Schiphol-Rijk, Pays-Bas

Belkin Suède
+46 (0) 8 510 630 00
Stockholm, Suède

Belkin SAS
+33 (0) 1 41 03 14 40
Boulogne-Billancourt, France

Belkin Iberia
+34 91 791 23 00
Alcobendas, Espagne

Belkin Nordics & Baltics
+45 (0) 3612 6000
Brøndby, Danemark

Belkin GmbH
+49 (0) 89 143405 0
Munich, Allemagne

Belkin Italie & Grèce
+39 02 862 719
Milan, Italie

Belkin Ltd.
+971 (0) 4 369 2705
Dubai Internet City, Dubai, EAU

© 2008 Belkin International, Inc. Tous droits réservés. Toutes les raisons commerciales sont des marques déposées de leurs fabricants respectifs.

PM00015ea



BELKIN®

**OmniView® PR03
Dual-User KVM Switch**

Start →

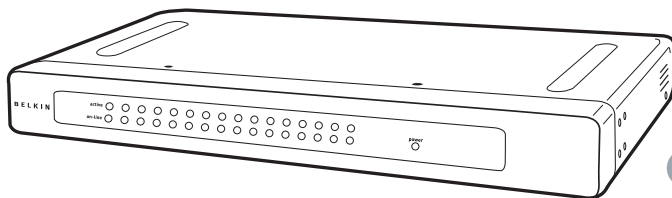

EN

FR

DE

NL

ES

IT

Installationsanleitung

F1DA208Zea
F1DA216Zea

Zur Installation des Switches benötigen Sie Folgendes:



OmniView PRO3
Dual-User KVM
Schrauben (enthalten)



Rackmount-
Halterungen mit
Schrauben (enthalten)



Netzteil (12 V/1 A) mit
Schuko-Stecker und
britischem Stecker



VGA Monitor



USB- und
PS/2-kompatibel



USB- oder PS/2-Maus



Dual-Port
Mikrokabelsatz von
Belkin
[Belkin Artikelnr. F1D9400-
XX (PS/2-Ausführung) oder
F1D9401-XX
(USB-Ausführung)]

Einleitung

Diese Installationsanleitung begleitet Sie Schritt für Schritt bei der Installation des OmniView PRO3 Dual-User KVM-Switches (des Switches).

Sollte es bei der Installation zu Problemen kommen, finden Sie im Benutzerhandbuch weitere Informationen.

Step 1. Mount the Switch

Der PRO3 Dual-User KVM-Switch enthält verstellbare Halterungen für den Einbau in 19-Zoll-Racks. Die Halterungen ermöglichen die Einstellung von drei Befestigungspositionen, sodass Sie die Vorderseite des Switches so anbringen können, dass er entweder bündig zu den Schienen abschließt oder über die Vorderseite der Schienen herausragt. Mit den folgenden einfachen Schritten erzielen Sie die gewünschte Einstellung.

- 1.1** Überlegen Sie sich, wie weit der Switch über das Rack hinausragen soll. Wählen Sie die entsprechende Bohrungsanordnung für die Halterungen aus.
- 1.2** Befestigen Sie die Halterung mit den beigegefügten Kreuzschlitzschrauben seitlich am Switch. (Siehe Abbildung unten.)

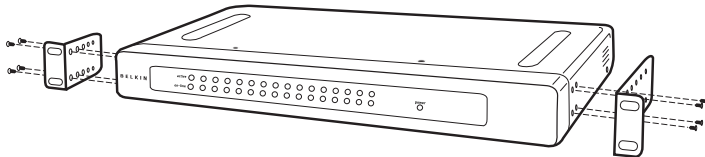

Der PRO3 Dual-User KVM-Switch enthält verstellbare Halterungen für den Einbau in 19-Zoll-Racks. Die Halterungen ermöglichen die Einstellung von drei Befestigungspositionen, sodass Sie die Vorderseite des Switches so anbringen können, dass er entweder bündig zu den Schienen abschließt oder über die Vorderseite der Schienen herausragt. Mit den folgenden einfachen Schritten erzielen Sie die gewünschte Einstellung.

1.3 Befestigen Sie den Switch im Rack. (Siehe Abbildung unten.)

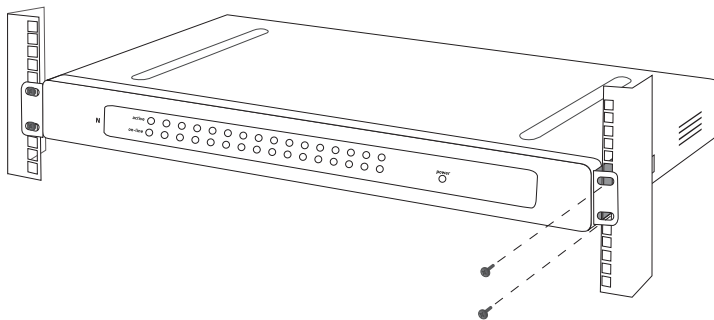

Ihr Switch ist jetzt sicher im Rack befestigt und Sie können die Konsole anschließen.

Schritt 2. Anschließen der Konsole

- 2.1** Schließen Sie Ihr Bildschirm-VGA-Kabel an den VGA-Anschluss an der Rückseite des Switches im Bereich „Console“ an. (Siehe Abbildung unten.)

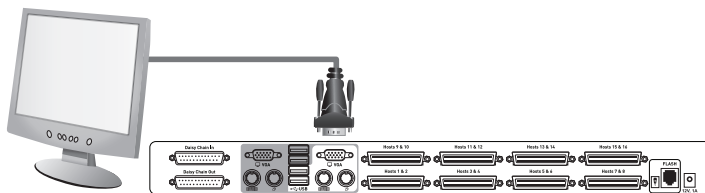

- 2.2** Schließen Sie Tastatur- und Mauskabel an die entsprechenden Anschlüsse im Bereich „Console“ (Konsole) an der Rückseite des Switches an. (Siehe Abbildung unten.)

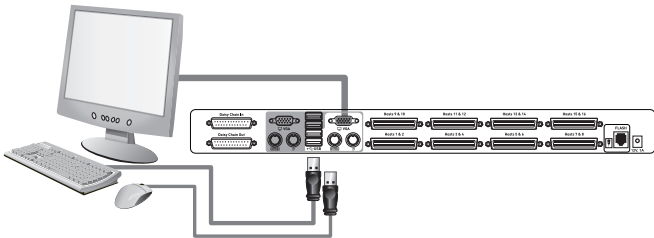

- 2.3** Wiederholen Sie zum Anschluss der zweiten Konsole Schritt 2.1 und 2.2.

- 2.4** Schließen Sie ein Ende des Dual-Port Mikrokabelsatzes von Belkin an den Switch an und schließen Sie das andere Ende an den Server an. (Siehe Abbildung unten.)

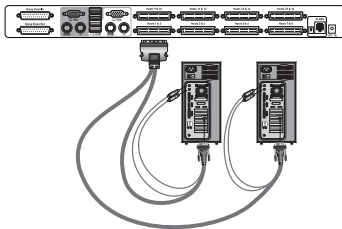

Belkin Dual-Port Mikrokabelsätze:
F1D9400-xx (PS/2-Ausführung)
F1D9401-xx (USB-Ausführung)

- 2.5** Schließen Sie das Netzteil an den Stromanschluss an der Rückseite des Switches an. (Siehe Abbildung unten.)

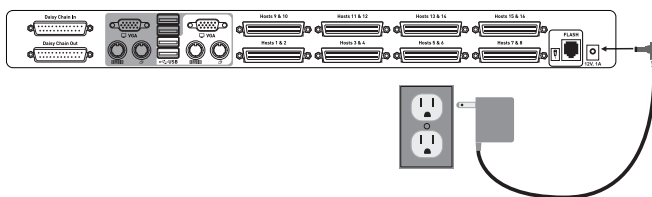

- 2.3** Fahren Sie die angeschlossenen Server hoch. Überprüfen Sie, ob Tastatur, Bildschirm und Maus an jedem Anschluss funktionieren. (Siehe Abbildung unten.)

Wenn Sie Ihren Switch in einer Kaskadierungskonfiguration installieren, finden Sie genauere Informationen im Benutzerhandbuch.

BELKIN®**OmniView® PR03
Dual-User KVM Switch**
BELKIN®

www.belkin.com

Belkin Ltd.
+44 (0) 1933 35 2000
Rushden, Großbritannien

Belkin B.V.
+31 (0) 20 654 7300
Schiphol-Rijk, Niederlande

Belkin Schweden
+46 (0) 8 510 630 00
Stockholm, Schweden

Belkin SAS
+33 (0) 1 41 03 14 40
Boulogne-Billancourt, Frankreich

Belkin Iberia
+34 91 791 23 00
Alcobendas, Spanien

Belkin Nordics & Baltics
+45 (0) 3612 6000
Brøndby, Dänemark

Belkin GmbH
+49 (0) 89 143405 0
München, Deutschland

Belkin Italy & Greece
+39 02 862 719
Mailand, Italien

Belkin Ltd.
+971 (0) 4 369 2705
Dubai Internet City, Dubai, VAE

© 2008 Belkin International, Inc. Alle Rechte vorbehalten. Alle Produktnamen sind eingetragene Marken der angegebenen Hersteller.

PM00015ea



BELKIN®

OmniView® PR03
KVM-switch voor twee
gebruikers

Hier beginnen →

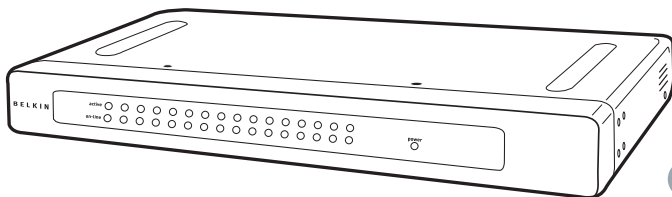

EN

FR

DE

NL

ES

IT

**Beknopte
installatiehandleiding**

F1DA208Zea
F1DA216Zea

Voor het installeren van de switch hebt u het volgende nodig:



OmniView PRO3
KVM-switch voor twee
gebruikers
(meegeleverd)



Rackmontagebeugels
en
schroeven
(meegeleverd)



12V/1A-voedingsadapter
(meegeleverd, incl.
Schuko- en Engelse
stekker)



VGA-monitor



USB- of PS/2-
toetsenbord



USB- of PS/2-muis



Belkin dual-port
KVM-kabels
[Artikelnummer Belkin:
F1D9400-XX (PS/2-
uitvoering), F1D9401-XX
(USB-uitvoering)]

Inleiding

Deze beknopte installatiehandleiding helpt u bij het installeren van de OmniView PRO3 KVM-switch voor twee gebruikers (de switch). Als u tijdens de installatie een probleem hebt, raadpleeg dan de handleiding.

Stap 1. Montage van de switch

De PRO3 KVM-switch voor twee gebruikers wordt geleverd met verstelbare montagebeugels die zich uitstekend lenen voor de installatie in 19"-racks. De montagebeugels kunnen in drie posities geplaatst worden en bieden u daarmee de mogelijkheid de frontplaat van de switch gelijk met de railenden te monteren of de switch voorbij de kop van de rails te plaatsen. Ga als volgt te werk om de gewenste stand in te stellen.

- 1.1 Bepaal hoever de switch uit het rack mag steken. Kies de plaats waar u de beugels wilt bevestigen.
- 1.2 Bevestig de beugel met de meegeleverde kruiskopschroeven op de zijkant van de switch. (Zie onderstaande afbeelding.)

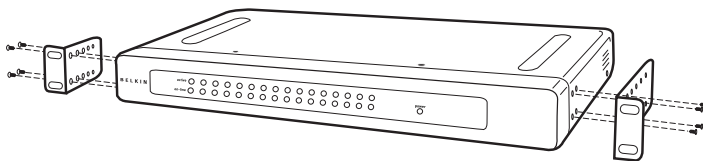

De PRO3 KVM-switch voor twee gebruikers wordt geleverd met verstelbare montagebeugels die zich uitstekend lenen voor de installatie in 19"-racks. De montagebeugels kunnen in drie posities geplaatst worden en bieden u daarmee de mogelijkheid de frontplaat van de switch gelijk met de railenden te monteren of de switch voorbij de kop van de rails te plaatsen. Ga als volgt te werk om de gewenste stand in te stellen.

1.3 Monteer de switch op de rails van het rack.
(Zie onderstaande afbeelding.)

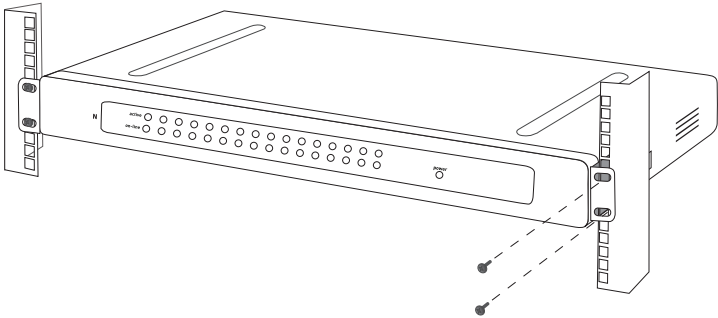

Your Switch is now mounted securely to the rack and you are ready to connect the console.

Stap 2. Aansluiting van de console

- 2.1** Sluit de VGA-kabel van uw monitor aan op de VGA-poort aan de achterkant van de switch, in het "Console"-gedeelte.
(Zie onderstaande afbeelding.)

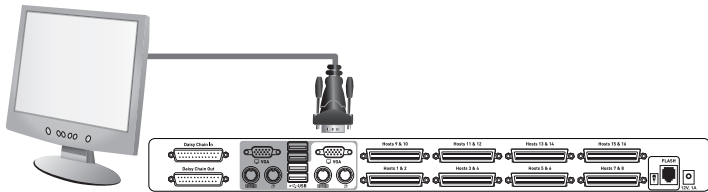

- 2.2** Sluit het toetsenbord en de muis aan op de toetsenbord- en muispoorten aan de achterkant van de switch, in het “Console”-gedeelte. (Zie onderstaande afbeelding.)

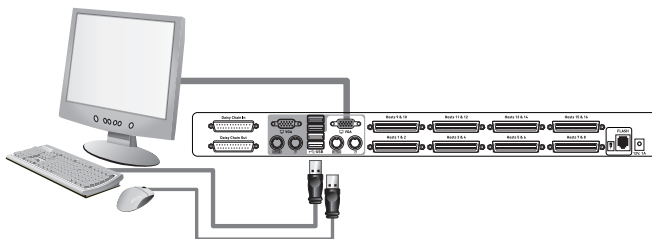

- 2.3** Herhaal stap 2.1 en 2.2 voor het aansluiten van de tweede console.
- 2.4** Sluit het ene uiteinde van de dual-port KVM-kabelset van Belkin aan op de switch en het andere uiteinde op de server. (Zie onderstaande afbeelding.)

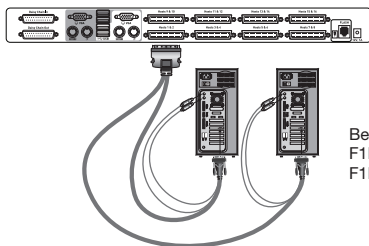

Belkin dual-port KVM-kabelsets:
F1D9400-XX (PS/2-uitvoering)
F1D9401-XX (USB-uitvoering)

- 2.5** Sluit de voedingsadapter aan op de voedingsaansluiting aan de achterkant van de switch. (Zie onderstaande afbeelding.)

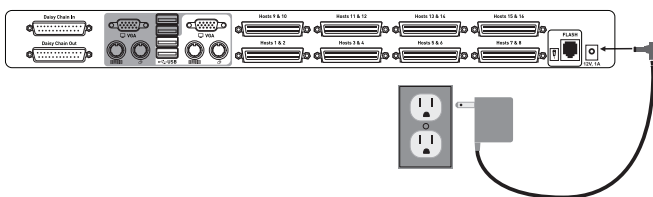

- 2.3** Zet de aangesloten servers aan. Controleer voor elke poort of het toetsenbord, de monitor en de muis correct werken. (Zie onderstaande afbeelding.)

Raadpleeg de handleiding als u uw switch in een daisychain-configuratie wilt gebruiken.

BELKIN®

OmniView® PR03 KVM-switch voor twee gebruikers

BELKIN®

www.belkin.com

Belkin Ltd.
+44 (0) 1933 35 2000
Rusten, Verenigd Koninkrijk

Belkin B.V.
+31 (0) 20 654 7300
Schiphol-Rijk, Nederland

Belkin Sweden
+46 (0) 8 510 630 00
Stockholm, Zweden

Belkin SAS
+33 (0) 1 41 03 14 40
Boulogne-Billancourt, Frankrijk

Belkin Iberia
+34 91 791 23 00
Alcobendas, Spanje

Belkin Nordics & Baltics
+45 (0) 3612 6000
Brøndby, Denemarken

Belkin GmbH
+49 (0) 89 143405 0
München, Duitsland

Belkin Italy & Greece
+39 02 862 719
Milaan, Italië

Belkin Ltd.
+971 (0) 4 369 2705
Dubai Internet City, Dubai, UAE

© 2008 Belkin International, Inc. Alle rechten voorbehouden. Alle handelsnamen zijn geregistreerde handelsmerken van de betreffende rechthebbenden.

PM00015ea



BELKIN®

Conmutador KVM
OmniView® PR03 Dual-User

Comience aquí →

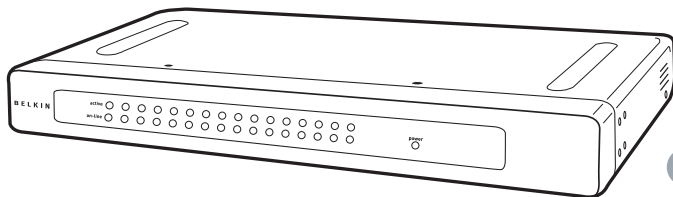

EN

FR

DE

NL

ES

IT

Guía de instalación rápida

F1DA208Zea
F1DA216Zea

Para instalar el conmutador, necesitará lo siguiente:



Conmutador KVM
OmniView® PRO3
Dual-User (incluido)



Montaje en bastidor
Engarces con
tornillos (incluidos)



Fuente de alimentación
12 V / 1 A
(incluida con enchufes
Schuko y R.U.)



Monitor VGA



Teclado USB o PS/2



Ratón USB o PS/2



Kit de microcableado
de puerto doble de
Belkin
Número de producto de
Belkin F1D9400-XX
(estilo PS/2), F1D9401-XX
(estilo USB)

Introducción

Esta guía de instalación rápida le guiará durante la instalación del conmutador KVM OmniView PRO3 Dual-User (el conmutador). Si se presentase algún problema durante la instalación, consulte el manual del usuario.

Paso 1. Montaje del conmutador

El conmutador KVM PRO3 Dual-User incluye soportes de montaje ajustables, para instalarlo en un bastidor de 19 pulgadas. Los soportes de montaje admiten tres posiciones de ajuste que le permitirán colocar la parte frontal del conmutador a la altura de los rieles o dejar que el conmutador sobresalga del bastidor. Siga estos sencillos pasos para conseguir la posición que prefiera.

- 1.1** Determine cuánto debe sobresalir el conmutador del bastidor. Seleccione los orificios y el tipo de montaje que desea llevar a cabo.
- 1.2** Fije el soporte al lateral del conmutador utilizando los tornillos Phillips incluidos. (Consulte el siguiente diagrama).

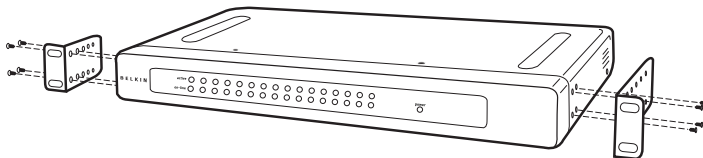

El conmutador KVM PRO3 Dual-User incluye soportes de montaje ajustables, para instalarlo en un bastidor de 19 pulgadas. Los soportes de montaje admiten tres posiciones de ajuste que le permitirán colocar la parte frontal del conmutador a la altura de los rieles o dejar que el conmutador sobresalga del bastidor. Siga estos sencillos pasos para conseguir la posición que prefiera.

1.3 Monte el Conmutador en los rieles del bastidor. (Consulte el siguiente diagrama).

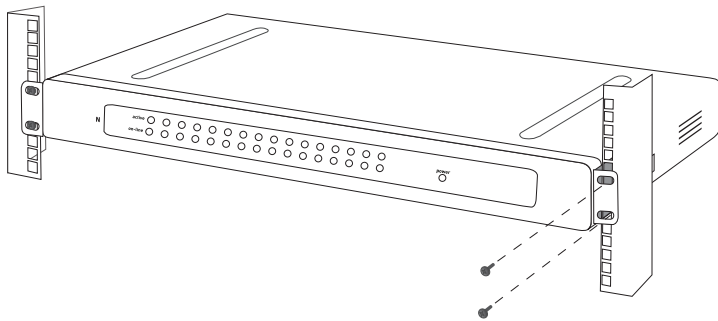

Su conmutador está ahora montado de forma segura en el bastidor y listo para conectarlo a la consola.

Paso 2. Conexión de la consola

- 2.1** Conecte su cable VGA del monitor al puerto VGA que se encuentra en la parte trasera del conmutador, en el apartado “Consola”. (Consulte el siguiente diagrama).

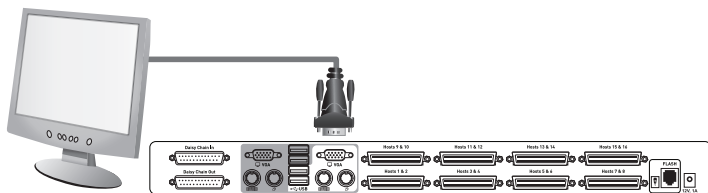

- 2.2** Conecte los cables de su teclado y ratón a los puertos para ratón y teclado que se encuentran en la parte posterior del conmutador, en el apartado “Consola”.
- (Consulte el siguiente diagrama).

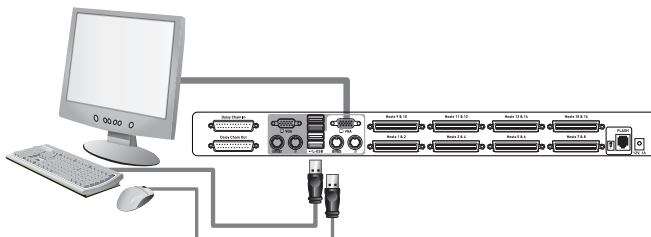

- 2.3** Repita los pasos 2.1 y 2.2 para conectar la segunda consola.

- 2.4** Conecte el extremo del kit de microcableado de doble puerto de Belkin al conmutador y después conecte el otro extremo al servidor. (Consulte el siguiente diagrama).

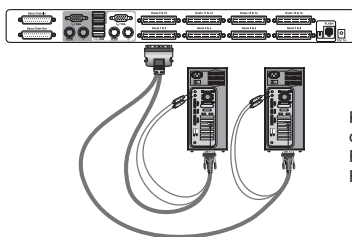

Kits de microcableado de puerto doble de Belkin:
F1D9400-XX (estilo PS/2)
F1D9401-XX (estilo USB)

- 2.5** Conecte la fuente de alimentación a la toma de alimentación de la parte trasera del conmutador.
(Consulte el siguiente diagrama).

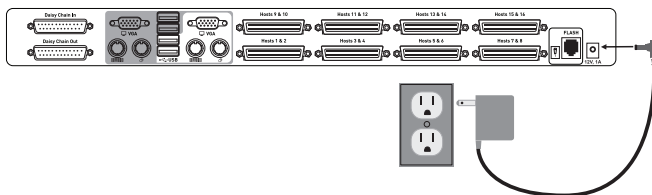

- 2.3** Encienda los servidores conectados. Verifique el funcionamiento del teclado, monitor y ratón en todos los puertos. (Consulte el siguiente diagrama).

Para instalar el Conmutador en una configuración de encadenamiento en margarita, remítase al manual del usuario.

BELKIN®**Conmutador KVM
OmniView® PR03 Dual-User**
BELKIN®

www.belkin.com

Belkin Ltd.
+44 (0) 1933 35 2000
Rushden (Reino Unido)

Belkin B.V.
+31 (0) 20 654 7300
Schiphol-Rijk (Países Bajos)

Belkin Sweden
+46 (0) 8 510 630 00
Estocolmo (Suecia)

Belkin SAS
+33 (0) 1 41 03 14 40
Boulogne-Billancourt (Francia)

Belkin Iberia
+34 91 791 23 00
Alcobendas (España)

Belkin Nordics & Baltics
+45 (0) 3612 6000
Brøndby (Dinamarca)

Belkin GmbH
+49 (0) 89 143405 0
Munich (Alemania)

Belkin Italy & Greece
+39 02 862 719
Milán (Italia)

Belkin Ltd.
+971 (0) 4 369 2705
Dubai Internet City, Dubai
(Emiratos Árabes Unidos)

© 2008 Belkin International, Inc. Todos los derechos reservados. Todos los nombres comerciales son marcas registradas de los respectivos fabricantes mencionados.

PM00015ea



BELKIN®

OmniView® PR03
Switch KVM per due utenti

Inizio →

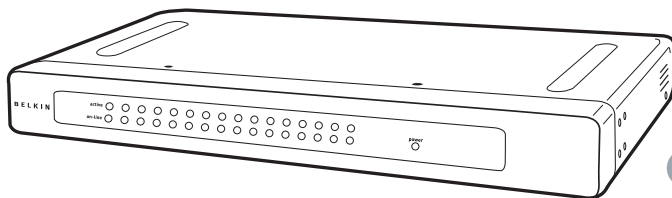

EN

FR

DE

NL

ES

IT

Guida di installazione rapida

F1DA208Zea
F1DA216Zea

Per installare lo switch sono necessari:



OmniView PRO3
Switch KVM per due
utenti (incluso)



Staffe di
montaggio con
viti (incluse)



Alimentatore di corrente
da 12 V/1 A
(incluso, con spine
Schuko e UK)



Monitor VGA



Tastiera USB o PS/2



Mouse USB o PS/2



Kit di microcavi
a doppia porta Belkin
[Codice prodotto Belkin
F1D9400-XX (PS/2) o
F1D9401-XX (USB)]

Introduzione

Questa guida ha lo scopo di fornirvi le informazioni fondamentali per eseguire l'installazione dello switch KVM per due utenti OmniView PRO3 (lo switch). Per qualsiasi problema nel corso dell'installazione, consultare il manuale d'uso.

Fase 1. Montaggio dello switch

Lo switch KVM per due utenti OmniView PRO3 comprende delle staffe regolabili ideali per il montaggio su rack da 19 pollici. Le staffe di montaggio prevedono tre posizioni di regolazione per consentire una collocazione dello switch da portarlo a livello con le estremità delle guide o di estendere lo switch oltre l'estremità anteriore delle guide. Seguire i passaggi riportati di seguito per ottenere la regolazione desiderata.

- 1.1** Decidere quanto si vuole che lo switch fuoriesca dal rack.
Scegliere uno schema di foratura delle staffe.
- 1.2** Fissare la staffa sul lato dello switch utilizzando le viti Phillips fornite (vedere lo schema riportato di seguito).

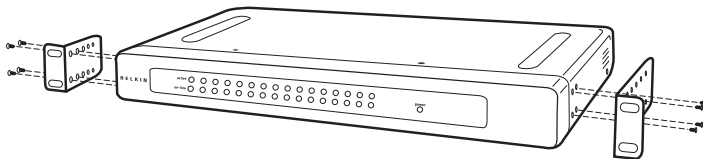

Lo switch KVM per due utenti OmniView PRO3 comprende delle staffe regolabili ideali per il montaggio su rack da 19 pollici. Le staffe di montaggio prevedono tre posizioni di regolazione per consentire una collocazione dello switch da portarlo a livello con le estremità delle guide o di estendere lo switch oltre l'estremità anteriore delle guide. Seguire i passaggi riportati di seguito per ottenere la regolazione desiderata.

1.3 Montare lo switch sulle guide del rack (vedere lo schema riportato di seguito).

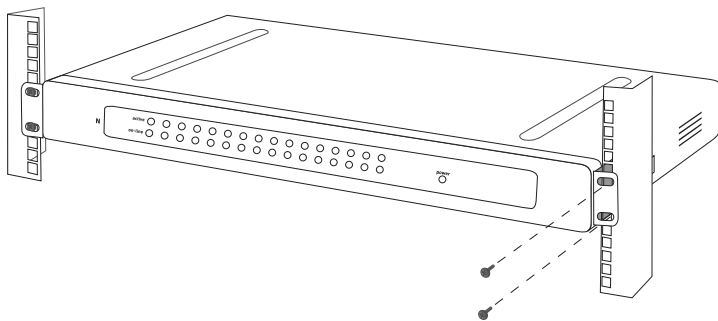

Lo switch ora è montato correttamente sul rack e si può collegare alla console.

Fase 2. Collegamento della console

- 2.1** Collegare il cavo VGA del monitor alla porta VGA sul retro dello switch nella sezione “Console” (vedere lo schema riportato di seguito).

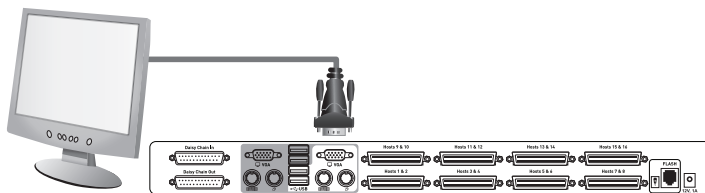

- 2.2** Collegare i cavi della tastiera e del mouse alle porte per tastiera e mouse sul retro dello switch nella sezione “Console” (vedere lo schema riportato di seguito).

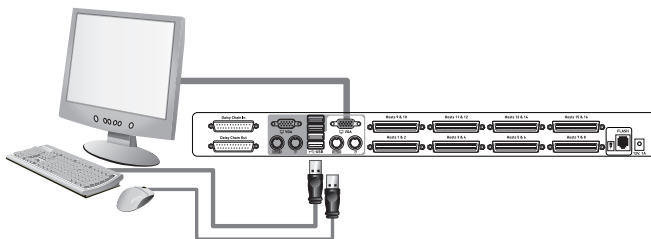

- 2.3** Per collegare la seconda console, ripetere le fasi 2.1 e 2.2.

- 2.4** Fissare una estremità del kit di microcavi a doppia porta Belkin allo switch e l'altra estremità al server (vedere lo schema riportato di seguito).

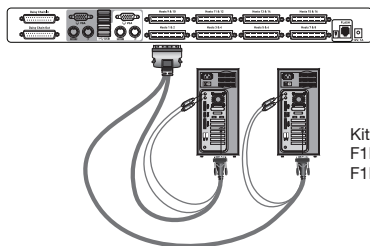

Kit di microcavi a doppia porta Belkin:
F1D9400-XX (PS/2)
F1D9401-XX (USB)

- 2.5** Collegare l'alimentatore al jack di alimentazione sul retro dello switch (vedere lo schema riportato di seguito).

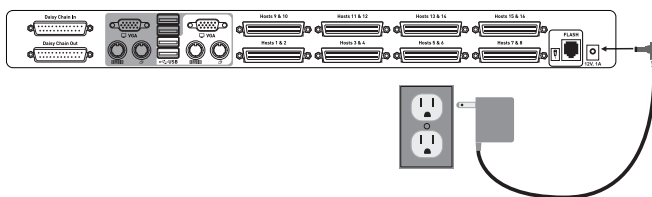

- 2.3** Accendere i server collegati. Verificare il funzionamento della tastiera, del monitor e del mouse su ciascuna porta (vedere lo schema riportato di seguito).

Per installare lo switch in configurazione a cascata, consultare il manuale d'uso.

BELKIN®**OmniView® PR03
Switch KVM per due utenti**
BELKIN®

www.belkin.com

Belkin Ltd.
+44 (0) 1933 35 2000
Rushden, Regno Unito

Belkin B.V.
+31 (0) 20 654 7300
Schiphol-Rijk, Paesi Bassi

Belkin Sweden
+46 (0) 8 510 630 00
Stoccolma, Svezia

Belkin SAS
+33 (0) 1 41 03 14 40
Boulogne-Billancourt, Francia

Belkin Iberia
+34 91 791 23 00
Alcobendas, Spagna

Belkin Nordics & Baltics
+45 (0) 3612 6000
Brøndby, Danimarca

Belkin GmbH
+49 (0) 89 143405 0
Monaco di Baviera, Germania

Belkin Italy & Greece
+39 02 862 719
Milano, Italia

Belkin Ltd.
+971 (0) 4 369 2705
Dubai Internet City, Dubai,
Emirati Arabi Uniti



© 2008 Belkin International, Inc. Tutti i diritti riservati. Tutti i nomi commerciali sono marchi registrati dei rispettivi produttori indicati.

PM00015ea
